

# Distributed Spectrum Allocation for Autonomous Cognitive Radio Networks

Anatolij Zubow, Michael Döring and Adam Wolisz  
 {zubow, doering, wolisz}@tkn.tu-berlin.de

**Abstract**—Cognitive Radio is a broadly discussed approach for better spectrum utilization by allowing Secondary Users (SU) the temporary usage of non-occupied spectrum licensed to Primary Users (PU). With the Non-Contiguous OFDM transmission technique even strongly fragmented spectrum can be efficiently accessed by SUs.

In this paper, we consider a set of independent, autonomous groups of SUs (networks consisting of a base station and a set of client stations) to operate in a shared set of temporary reusable frequencies. We present a fair, distributed spectrum allocation algorithm with low computational complexity and low control data overhead. Our approach assures that in case a PU is reclaiming some spectrum this will affect all co-located SU groups in the same fair manner.

Simulation results demonstrate the convincing efficiency of this algorithm as compared with a centralized, optimal solution.

**Index Terms**—Cognitive Radio, Non-Contiguous OFDM, Ad-hoc, Opportunistic Spectrum Allocation

## I. INTRODUCTION

Most recent studies, e.g. [1], predict that mobile traffic will increase more than ten times in the next four years. Therefore, future systems need to be extremely efficient in terms of spectrum usage in order to provide the required capacity within the limits of available spectrum.

A promising solution to achieve this goal is the Cognitive Radio (CR) approach. It is based on the observation that spectrum assigned to license holders, called Primary Users (PU), remains frequently unutilized in some geographical areas even over long time periods. The CR approach allows Secondary Users (SU) to utilize parts of licensed spectrum temporary not claimed by the proper PUs based on Opportunistic Spectrum Allocation (OSA). Furthermore, Non-Contiguous OFDM (NC-OFDM) transmission technique allows SUs to utilize efficiently even fragmented spectrum as it becomes available [2].

In this paper we assume that the information about the availability of spectrum for secondary usage is provided for any interested SU. This is obviously the case if a spectrum database is available as suggested by the FCC [3] where any interested CR device can query for spectrum available for secondary usage in its proximity.

It is envisioned that in the future numerous groups of SUs will access such available spectrum simultaneously. Thus, an intelligent and efficient link layer mechanism that allows collision-free (with respect to other SU groups) and interference-free (with respect to PUs) communication is required. Any uncoordinated spectrum access will inevitably result in interference between groups of SUs and hence in a low spectral efficiency. Assuming a large number of such

SU groups, possibly frequently appearing and disappearing, a centralized “lease and re-lease” approach using dedicated brokers is unlikely to be efficient. Therefore, we propose to allocate distinct parts of the available secondary spectrum to individual SU groups in a distributed manner.

In this paper we present a fully distributed low complexity (with respect to computation) and efficient (with respect to communication overhead) algorithm, which assigns parts of the spectrum available for secondary usage to individual SU groups. Our algorithm is fair in the sense that it equally splits the spectrum among all spatially overlapping groups of SUs.

To the best of our knowledge this is the first approach which exploits this level of flexibility of NC-OFDM in OSA. With wideband NC-OFDM system we are able to simplify the allocation problem by splitting the problem into spectrum allocation and PU protection. Moreover, our proposed algorithm is a distributed approach for OSA in CRNs without requiring a Common Control Channel (CCC).

The rest of the paper is organized as follows. In Sec. II, system under study and the problem formulation are introduced. Sec. III presents the proposed heuristic for spectrum allocation. The performance is evaluated by means of simulations and compared with the centralized optimum solution in Sec. IV. Sec. V discusses related research. Finally, Sec. VI summarizes our main findings and concludes the paper.

## II. MODELING AND PROBLEM STATEMENT

This section describes the system model and formulates the spectrum allocation problem as an optimization problem.

### A. System Model

We consider a wireless communication system, in which a range of spectral frequencies from  $F_{min}$  to  $F_{max}$  can be used in Cognitive Radio manner. We assume that all frequencies are licensed, but there exists a database of spectrum fragments available for secondary usage in a given time interval over a given spacial area. The available spectrum might be strongly fragmented. Moreover, the allowance for secondary usage can be revoked on a short notice.

Furthermore, we assume that the secondary usage is claimed by a set of secondary networks. Each such secondary network is in fact a group of SU nodes with a designated cluster leader, referred further on as CR Base Station (CR-BS) as depicted in Fig. 1. The CR-BSs have the possibility to get information from the above defined spectrum database.

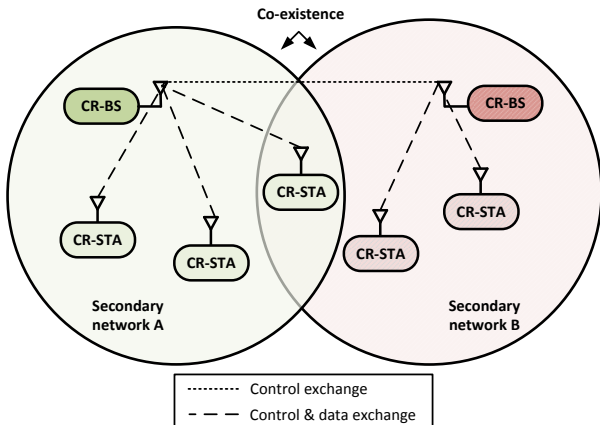

Fig. 1. **System Model.** The CRN under study consists of a set of secondary networks each with a CR Base Station (CR-BS) and various CR Client Stations (CR-STA).

We do not make any specific assumptions as for how this is to happen; we just assume that each CR-BS has always an up to date knowledge of the data stored in the spectrum database (e.g. by using a publish–subscribe approach with notifications of relevant changes). The remaining nodes, referred further on as CR Stations (CR-STA), are associated with the CR-BSs. Since the spectrum is selected by the CR-BS the remaining network participants (CR-STA) follow the spectrum selection done by the BS.

All nodes are equipped with a half-duplex wideband NC-OFDM transceiver. The total spectrum, i.e.  $F_{min}$  to  $F_{max}$ , is divided into NSC subcarriers, which equals the size of the FFT. Adjacent subcarriers are grouped into physical subchannels resulting in a total number of SCH subchannels. The wireless communication between neighboring CR-BSs is limited to the in-band exchange of control messages (beacons). All nodes are time synchronized, i.e. the CR-BSs are synchronized with the help of Global Positioning System (GPS) or via network time protocol, whereas the CR-STAs are synchronized through the control messages of the associated CR-BS. A coarse time synchronization is needed for in-band signaling (beacon exchange) due to the limitations of the half-duplex transceivers.

Finally, PUs which are licensed spectrum holders are assumed to be totally unaware of secondary spectrum usage and must be protected by any means. In order to protect PUs the spectrum shaping at SUs is achieved using NC-OFDM [4]. In particular null and cancellation subcarriers are inserted (Fig. 2). Moreover windowing techniques can be used to increase the depth of spectrum holes in order to lower the level of interference towards PUs [2].

### B. Problem Description

The spectrum allocation problem in the CRN is to find an optimal allocation of spectrum not claimed by PUs to CR-BSs, while making sure that there is no interference between CR-BSs, as well towards the PUs. This optimization problem can be formulated as follows:

**Instance:** A set of  $\mathcal{V}$  CR-BSs and an undirected graph

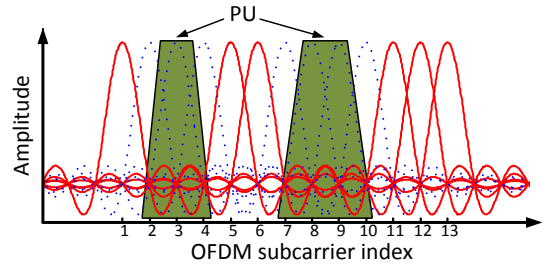

Fig. 2. **Spectrum shaping using OFDM.** Subcarriers being blocked by PUs are disabled (dotted curve).

$I_{SU} = (V_{SU}, E_{SU})$  representing the interference between CR-BSs. Here CR-BSs in interference range are represented by vertices, which means, a link exists between two vertices  $v$  and  $u$ , if  $v$  and  $u$  interfere with each other. Moreover, a set of PUs and a directed graph  $I_{PU} = (V_{PU}, E_{PU})$  representing the interference from the CR-BSs towards the PUs.

**Objective:** The goal is to find a valid assignment of subcarriers for all CR-BS nodes:

$$A_{v,s} = \begin{cases} 1, & \text{if subcarrier } s \text{ is assigned to node } v \\ 0, & \text{otherwise} \end{cases} \quad (1)$$

such that the following term is maximized. This means that the available subcarriers are distributed among all nodes in order to achieve **max-min fairness** [5]:

$$A = \arg \max_A \min_{v \in \mathcal{V}} \left( \sum_{s \in S} A_{v,s} \right) \quad (2)$$

subject to:

(I) **Interference avoidance:** assignment of subcarrier  $s$  to node  $v$  does not cause interference to nodes in interference distance, i.e. if  $A_{v,s} = 1$  then  $\forall u : (v, u) \in E_{PU} \rightarrow A_{u,s} = 0$ .

(II) **Outage avoidance:** every CR-BS  $v$  gets a non-empty spectrum share, i.e.  $\exists s : A_{v,s} = 1$ .

(III) **PU protection:** assignment of subcarrier  $s$  to node  $v$  does not cause interference towards any PU, i.e. if  $A_{v,s} = 1$  then  $\forall u \in \mathcal{P} : (v, u) \notin E_{PU}$ .

This optimization problem is a binary integer linear programming problem which is known to be NP-complete ( $\mathcal{NPC}$ ).

TABLE I  
DEFINITIONS

$\mathcal{V}$	Set of CR-BS nodes
$\mathcal{V}_v$	Largest connected subgraph of node $v$
$v$ or $u$	CR-BS nodes
$r_v$	Ranking number of node $v$
$r_v^{\max}$	Highest ranking number in $\mathcal{V}_v$ as known by $v$
$G$	Network graph of CR-BS nodes
$A_{v,s}$	Assignment of $s$ subcarriers to node $v$
$V_{PU}$	Set of PUs
$E_{PU}$	Links in PU interference graph between CR-BSs and PUs
$V_{SU}$	Set of CR-BS nodes
$E_{SU}$	Links in SU interference graph between CR-BSs
NSC	Total number of OFDM subcarriers
GSC	Total number of guard carriers per subchannels
SCH	Number of physical/logical subchannels

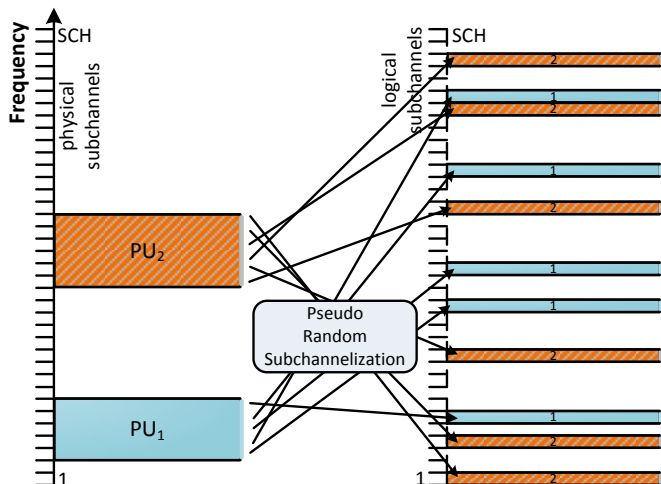

Fig. 3. **Distributed subchannelization scheme.** Logical subchannels are mapped randomly to physical subchannels.

### III. PROPOSED SPECTRUM ALLOCATION

The optimal solution to allocate spectrum in a CRN is a complex task to be efficiently implemented in practice. Therefore, in order to reduce complexity, we divide the overall optimization problem into two independent major tasks:

- 1) **Collision-free assignment** of subchannels to CR-BSs without considering any spectrum utilization by PUs.
- 2) **PU protection** by excluding OFDM subcarriers blocked by PUs from the set of assigned subcarriers.

#### A. Collision-free Assignment

In the following we present a fully distributed algorithm, which assigns each CR-BS node a collision-free portion of the spectrum with respect to other CR-BSs in interference range. The basic idea is that every CR-BS computes a so-called ranking number which is unique in its two-hop neighborhood. Furthermore, every node knows the highest, so far assigned, ranking number in the network. From both the actual and the highest assigned ranking number a CR-BS node is able to calculate the portion of the spectrum, i.e. set of subchannels, to be used.

1) *Estimating the Interference Graph:* In order to avoid interference between CR-BSs the following widely used heuristic [6] is used to estimate the interference graph  $I_{SU}$  from the network graph of CR-BSs  $G$ . It follows the assumption that the interference range around a CR-BS is twice the wireless communication range. Hence, we have to make sure that any subcarrier is used at most once in the two-hop neighborhood. Note, that  $G$  is estimated by sending beacon frames on the in-band control channel (Fig. 4). Hence,  $I_{SU}$  is constructed from  $G$  by adding an edge between two vertices having the same neighbor in common.

2) *Calculating the Spectrum Share:* The prerequisite step is, that a new CR-BS node  $v$  is time synchronized with all its neighboring CR-BS nodes. By analyzing the received beacon frames node  $v$  knows the nodes addresses and assigned ranking

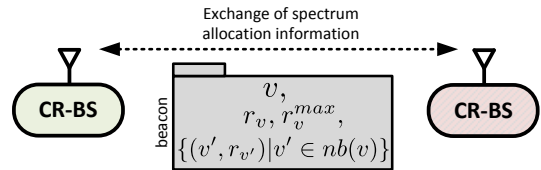

Fig. 4. **Exchange of control messages** between CR-BSs for neighbor discovery and for sharing spectrum allocation information.

numbers in its two-hop neighborhood as well as the highest, so far known, ranking number in the network<sup>1</sup> (Fig 4). With the help of this information node  $v$  calculates its own ranking number which is the smallest not already assigned ranking number in its two-hop neighborhood. The complete algorithm is shown in Listing 1.

With the help of its ranking numbers  $r_v$  and the highest so far assigned ranking number  $r_v^{\max}$  node  $v$  is able to calculate the size of the spectrum share to be used, i.e.  $r_v/r_v^{\max}$ . The exact part of the spectrum, i.e. set of subchannels, to be used is computed from the total number of available subchannels SCH which are in the interval  $(\lceil \frac{SCH \times (r_v - 1)}{r_v^{\max}} \rceil + 1, \lceil \frac{SCH \times r_v}{r_v^{\max}} \rceil)$ .

3) *Handling Ranking Collisions:* Concurrent CR-BS node joins can cause problems, more precisely if two or more nodes located in the same two-hop neighborhood join the network simultaneously. In such a situation a ranking number collision occurs resulting in interference between SU cells due to the overlapping of allocated spectrum. However, such a collision can be detected locally by the joining nodes. The collision resolution is to re-run the algorithm for calculating the ranking number (Listing 1) after a random waiting time (back-off).

Moreover, ranking number collisions can also be the result of network merging, i.e. two disconnected parts of the network are merged due to a joining node which connects both parts. Again, such a collision can be easily detected locally by the joining node  $v$  itself which executes a collision resolution algorithm as follows. Therefore, node  $v$  forces the  $n - 1$  nodes of those using the same ranking number, to recalculate their ranking numbers. This is achieved by sending a control message over the in-band control channel. Note, that the proposed scheme is robust with respect to spectrum re-allocation against merging of networks, because only the ranking numbers of the nodes at the edge between the merging networks need to be recalculated, resulting only in local spectrum re-allocation.

#### B. PU Protection

By using Algorithm 1 every CR-BS node is able to compute its spectrum share to be used within its cell. However, in a CR system an additional step is required. During this step those parts of the spectrum being used by PUs need to be excluded which is achieved by exploiting the flexible spectrum shaping capabilities of NC-OFDM. To avoid the situation that the assigned spectrum of some CR-BS is fully blocked by PUs, a distributed subchannel permutation scheme,

<sup>1</sup>Precisely it is the highest rank number in the largest connected subgraph to which node  $v$  belongs to, i.e.  $r_v^{\max} = \max\{r_{v'} | v' \in \mathcal{V}_v\}$  and  $\mathcal{V}_v \subseteq \mathcal{V}$ .

**Algorithm 1** Calculate and set ranking number for a node.

**Require:**  $v \in \mathcal{V}$

▷ The node  $v$  for which ranking number is calculated.

**Ensure:**

▷ Assigned ranking number  $r_v$  is unique in 2-hop neighborhood of node  $v$ .

1: **procedure** SELECTRANKNUMBER

2:  $\mathbb{R} \leftarrow \mathbb{N}$

▷ Ranking numbers are natural numbers.

3:  $\mathbb{R}' \leftarrow \{r \in \mathbb{R} \wedge r \neq r_{v'}, v' \in \text{twohopnb}(v)\}$  ▷ Keep ranking numbers not already assigned in two-hop neighborhood.

4:  $r \leftarrow \min\{\mathbb{R}'\}$

▷ Select the smallest free ranking number.

5:  $\text{assign}(v, r)$

▷ Assign ranking number  $r$  to node  $v$ .

6: **end procedure**

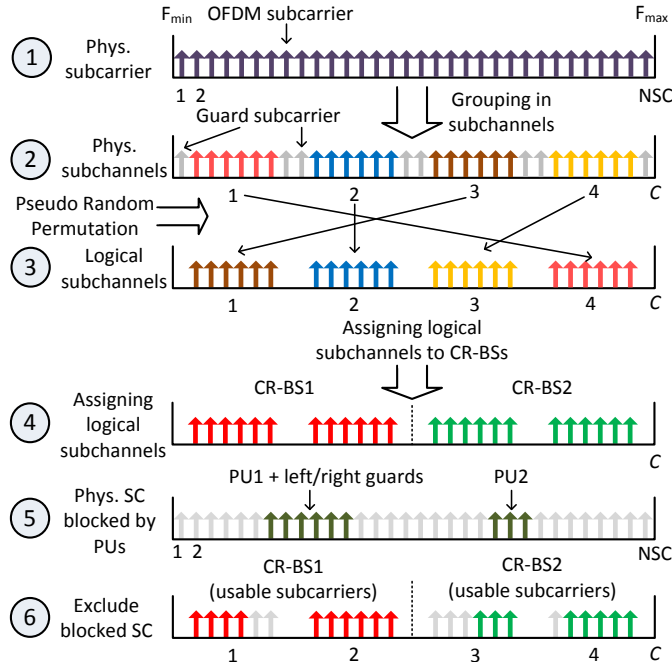

Fig. 5. **Illustrative example.** This example shows how the spectrum is assigned to CR-BS node.

which randomly maps the logical subchannels to physical subchannels is applied. This results in a scattering of adjacent subcarriers being blocked by a PU over the whole spectrum range, thus, avoiding the situation of hurting just a single CR-BS (Fig. 3). Note, due to the applied distributed subchannel permutation scheme, adjacent subchannels can be assigned to different CR-BS nodes. This results in subcarrier interference. Therefore, from the block of adjacent subcarriers, which are grouped as subchannel, edge subcarriers need to be used as guard carriers.

Listing 2 shows how from the set of assigned resource units subcarriers being blocked by co-located PUs are excluded. An illustrative example is given in Fig. 5. We can identify the following six steps: 1) calculating the physical subcarriers over the total spectrum ( $F_{min}$  to  $F_{max}$ ), 2) grouping adjacent physical subcarriers into physical subchannels, 3) random permutation of physical subchannels to logical subchannels, 4) assigning logical subchannels to CR-BSs according to their ranking numbers, 5) estimating physical subcarriers being blocked by PUs and 6) excluding blocked subcarriers from the assigned SU spectrum.

### C. Optimization – Utilizing Unused Spectrum

The size of the spectrum share assigned to a CR-BS node depends on the highest assigned ranking number,  $r^{max}$ , in the network. Every CR-BS node gets  $1/r^{max}$  of the total spectrum share. However, in a realistic network we have dense, as well as sparse network parts, i.e. some node (e.g. network edge nodes) will have only a few neighboring CR-BSs, while others might have lots of neighbors. So, after spectrum assignment in the sparse parts of network, some parts of the spectrum, i.e. ranking numbers, remain unused. The objective of the following algorithm extension is to utilize this unused spectrum, which is achieved as follows.

In addition to the ranking number, every node  $v$  calculates a set of additional ranking numbers  $T_v$ .  $T_v$  contains the ranking numbers not being used in its two-hop neighborhood. To avoid collisions on these additional ranking numbers, every node  $v$  has to report the set  $T_v$  to its two-hop neighbors, which is calculated as follows:

$$T_v = \{t | t \in \{1, \dots, r_v^{max}\} \wedge t \neq r_{v'} \wedge t \notin T_{v'}, v' \in \text{twohopnb}(v)\}.$$

Therefore, in Listing 2 line two needs to be replaced by the instructions given in Listing 3.

### D. Discussion

In the absence of any PUs the proposed algorithm ensures that every CR-BS gets a fair spectrum share which depends on the density of the network. In a CRN some parts of the assigned spectrum can be blocked by PUs and thus have to be excluded from SU usage. The proposed random subchannel permutation scheme ensures that every CR-BS node gets a free fraction of spectrum with high probability. The chance, that a node gets no spectrum, i.e. its assigned part of the spectrum is completely shaded by PUs, is very small and can be decreased by raising the total number of subchannels.

The proposed algorithm is robust with respect to the appearance and disappearance of PUs, i.e. only the allocated spectrum of the SUs in interference range of a particular PU need to be reallocated, specifically only the second task must be performed (Sec. III-B). The algorithm is also robust with respect to the appearance and disappearance of SUs (CR-BS), i.e. the spectrum needs to be reallocated only if the maximum ranking number  $r_v^{max}$  in the largest connected subgraph changes. Finally, the proposed algorithm is able to deal with network merges, i.e. the merging of two networks results only in the recomputation of the ranking numbers of the edge nodes between the two networks.

---

**Algorithm 2** Calculating the set of resource units to be used by a CR-BS node.

---

**Require:**  $r_v, r_v^{\max}$   $\triangleright$  The ranking number of node  $v$  as computed by Algorithm 1 and the highest known ranking number assigned in the network.

**Ensure:**  $\triangleright$  The assigned set of subcarriers (RUs) to node  $v$ ,  $\mathbb{S}_v \subseteq \mathbb{S}$ , are used only once in two-hop neighborhood of node  $v$  and are not blocked by any detected PU.

1: **procedure** ASSIGNRESOURCEUNITS

2:  $\mathbb{L}_v \leftarrow \{l \mid \lceil \frac{\text{SCH} \times (r_v - 1)}{r_v^{\max}} \rceil + 1 \leq l \leq \lceil \frac{\text{SCH} \times r_v}{r_v^{\max}} \rceil\}$   $\triangleright$  Set of logical subchannels to be used.

3:  $\mathbb{P}_v \leftarrow \{\text{perm}(l) \mid l \in \mathbb{L}_v\}$   $\triangleright$  Distributed subchannelization – random mapping of logical to physical subchannels.

4:  $\mathbb{S}_v \leftarrow (s_1, \dots, s_{\text{NSC}}) \mid s_i = \begin{cases} 1 & \text{if } \exists p \in \mathbb{P}_v : (p-1) \times \frac{\text{NSC}}{\text{SCH}} + 1 + \frac{\text{GSC}}{2} \leq i \leq p \times \frac{\text{NSC}}{\text{SCH}} - \frac{\text{GSC}}{2}, \forall i \in \{1 \dots \text{NSC}\} \\ 0 & \text{otherwise} \end{cases}$

$\triangleright$  Bit vector indicating which data subcarriers are assigned to node  $v$ .

5:  $\mathbb{S}_v \leftarrow \text{AND}(\mathbb{S}_v, \text{DBSpectrumMask}(\text{geoLoc}(v)))$   $\triangleright$  Excluded RUs using data from spectrum database.

6: **return**  $\mathbb{S}_v$

7: **end procedure**

---

**Algorithm 3** Extension of line two in Algorithm 2 to calculate the set of RUs to be used by a CR-BS node.

---

1:  $T_v = \{t \mid t \in \{1, \dots, r_v^{\max}\} \wedge t \neq r_v \wedge t \notin T_{v'}, v' \in \text{twohopnb}(v)\}$   $\triangleright$  Set of unused ranking numbers in 2-hop nb.

2:  $\text{assign}(v, T_v)$   $\triangleright$  Assign additional ranking numbers  $T_v$  to node  $v$ .

3:  $\mathbb{L}_v \leftarrow \{l \mid \lceil \frac{\text{SCH} \times (r_v - 1)}{r_v^{\max}} \rceil + 1 \leq l \leq \lceil \frac{\text{SCH} \times r_v}{r_v^{\max}} \rceil\}$   $\triangleright$  Set of logical subchannels according to primary ranking number.

4: **for all**  $x \in T_v$  **do**  $\triangleright$  For every additional ranking number.

5:  $\mathbb{L}_v \leftarrow \mathbb{L}_v \cup \{l \mid \lceil \frac{\text{SCH} \times (x - 1)}{r_v^{\max}} \rceil + 1 \leq l \leq \lceil \frac{\text{SCH} \times x}{r_v^{\max}} \rceil\}$   $\triangleright$  Add additional logical subchannels.

6: **end for**

---

Finally, the proposed algorithm is fully distributed and requires only local messaging, which means, the exchange of the actual and the highest known ranking number between spatially co-located CR-BSs. Thus, the control message overhead is very low.

#### IV. PERFORMANCE EVALUATION

The performance of the proposed spectrum allocation scheme is analyzed in this section. First, we describe the evaluation methodology. Second, the results from performance evaluation are presented.

##### A. Methodology

The performance of the proposed algorithm is analyzed by means of simulations using Matlab. In Experiment 4 the results of our proposed algorithm are further compared with solutions computed by ZIMPL and the Gurobi solvers.

Two different random network topologies were considered. First, we evaluate a random network topology with fixed node degree  $\alpha$  of 2,4,6 and 8 respectively. Second, we address a random network where every node has at least one neighbor. This results in networks with variable node degree. In both cases the CR-BS nodes joined the network as follows. In each round, from the set of not already joined nodes, a single node was randomly selected to join the network. The presented results show the spectrum allocation after all  $\mathcal{V}$  nodes have joined the network.

As the performance metric, we calculated the number of available data subcarriers at every CR-BS node excluding guard carriers, as well as subcarriers blocked by PUs. As stated in Eq. 2 our main objective is to find a fair spectrum

allocation where the minimum number of assigned subcarriers among CR-BSs is maximized. The explicit parameters of every experiment are given in Table II.

##### B. Simulation Results

**Experiment 1: (Impact from PUs)** To evaluate the impact from PUs on the proposed allocation scheme we considered the random network topology with a fixed node degree of  $\alpha$ . The number of subcarriers per subchannel ( $\text{NSC}/\text{SCH}$ ) was set to 32 whereas the number of guard carriers per subchannel was 2 resulting in 256 subchannels in total. A single global PU was simulated whose occupied spectrum share was varied from 0 to 50% of the total available spectrum.

**Result 1:** From Fig. 6 we can observe that the proposed allocation scheme ensures that every CR-BN node gets a free share of the spectrum. The difference between those nodes who are getting the most and the least subcarriers is small even in the case where the PU occupies a large part of the spectrum. This is possible because the proposed subchannelization scheme scatters the adjacent subcarriers blocked by PUs over the whole spectrum.

Moreover, an increase in the number of neighbors ( $\alpha$ ) narrows the size of the assigned spectrum. This is due to the enforced strict interference avoidance strategy.

**Experiment 2: (Optimal number of subcarriers per sub-channel)** According to the proposed subchannelization scheme adjacent subcarriers are grouped into subchannels. Because adjacent subchannels can be assigned to different CR-BS nodes we have to insert guard carriers resulting in wastage of spectrum. In the following we evaluate the optimal number

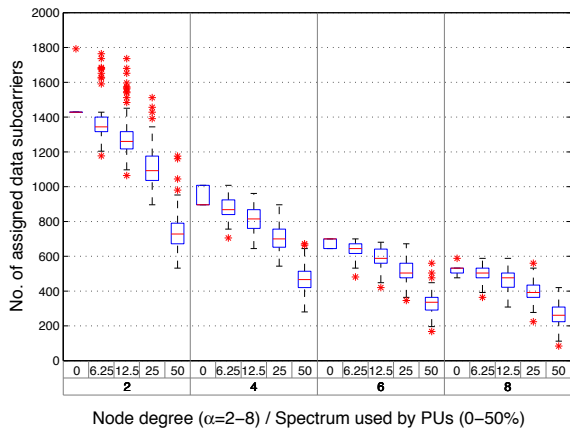

Fig. 6. Impact of PU on spectrum assignment.

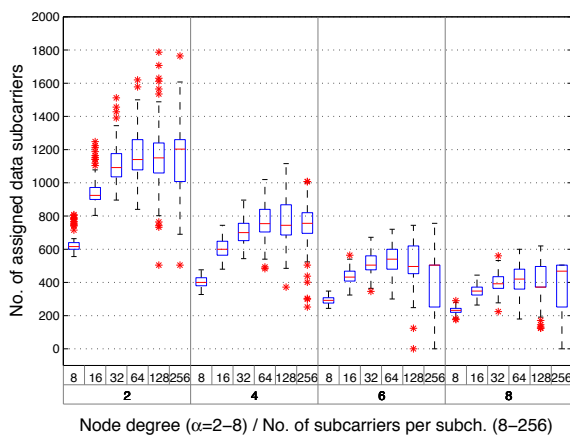

Fig. 7. Impact of number of subcarriers per subchannel on spectrum assignment.

of subcarriers (incl. two guards) in each subchannel, which is a trade-off between efficiency (small guard carrier overhead) and probability of being blocked by PUs. The latter can be explained as follows. The scattering is done on the subchannel level, i.e. the mapping of physical subchannels to logical subchannels is random. The larger the number of subchannels the larger the effect of scattering the adjacent subcarriers being blocked by PUs because the subcarriers within a subchannel are adjacent. For this purpose a single global PU was simulated whose spectrum share was fixed to 50% of the total available spectrum. Further, a random network topology with a fixed node degree of  $\alpha$  was considered.

**Result 2:** From Fig. 7 we observe that node degree  $\alpha$  has only a minor impact on the optimal number of subcarriers per subchannel. The larger the number of subcarriers per subchannel, i.e. the smaller the number of subchannels, the higher the variation of assigned subcarriers becomes. If only a few subchannels are used, it can happen that some nodes will get no free spectrum, i.e. all assigned subcarriers are fully blocked by the PU. Thus, a good trade-off between fairness among CR-BS nodes and efficiency is achieved with 32 subcarriers per subchannel and thus 256 subchannels in total.

### Experiment 3: (Impact of proposed algorithm extension)

In the following we will quantify the improvement to our spectrum sharing algorithm proposed in Sec. III-C. Therefore a random network topology with variable node degree and different number of nodes is considered. The number of placed PUs is 12, 25 and 50 for a network with 50, 100 and 200 nodes, respectively. The PUs are placed uniform randomly. Each PU occupies a small random part of the spectrum, i.e. 2%, 1% and 0.5% for a network with 50, 100 and 200 nodes, respectively.

**Result 3:** From Fig. 8 we can observe that with the proposed algorithm extension there are CR-BSs having significantly more spectrum assigned which otherwise would be unused. In particular the gain is especially high for nodes at network edges or in the sparse parts of the network. The median of the assigned number of subcarriers over all CR-BSs remains nearly the same but for at least 25% of the nodes the number of assigned subcarriers is up to doubled.

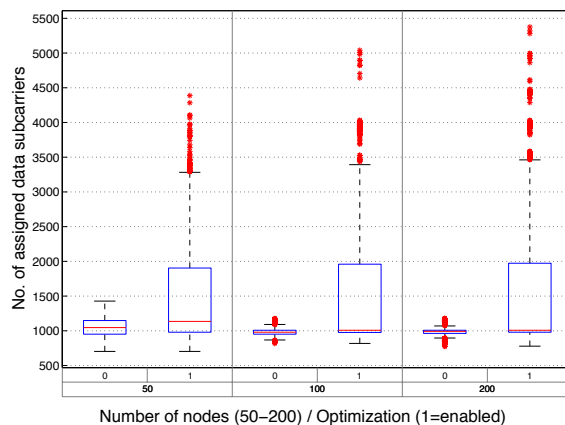

Fig. 8. Impact of the algorithm extension (Sec. III-C).

**Experiment 4: (Comparison with global optimum)** Finally, we compare the results of our proposed heuristic with the global optimal, i.e. centralized, solution. The latter was computed using ZIMPL<sup>2</sup> and the Gurobi<sup>3</sup> solver for computing the mixed-integer problem given in Sec. II-B. Again, a random network topology with a fixed node degree of  $\alpha$  was considered.

**Result 4:** Fig. 9 shows the minimum number of allocated data subcarriers among the nodes as computed by the proposed algorithm relative to the global optimal solution for networks with different node degrees and available secondary spectrum. The following observation can be made. First, in the absence of any PU the performance of our approach is 60-70% of the optimum. This is a good value since we considered the worst case scenario where the random joining of nodes resulted in lots of network merges.

In contrast to the optimum solution with a complexity of  $\mathcal{N}^3$  our heuristic has only a constant complexity,  $\mathcal{O}(1)$ , which only depends on the number of nodes in the local two-hop neighborhood around a node and thus is independent from

<sup>2</sup>Zuse Institute Mathematical Programming Language, <http://zimpl.zib.de/>

<sup>3</sup>Gurobi Optimizer, <http://www.gurobi.com>

TABLE II  
EXPERIMENTAL PARAMETERS SUMMARY

	# of nodes	node degree	NSC/SCH	guards/SCH	# of PUs	PU occupancy	PU placement	FFT
Experiment 1	50	2,4,6,8	32	2	1	0-50% variable	one global PU	8192
Experiment 2	50	2,4,6,8	8,16,32,64,128,256	2	1	50% fixed	one global PU	8192
Experiment 3	50,100,200	variable	32	2	12,25,50	2%,1%,0.5%	uniformly distributed	8192
Experiment 4	50	2,4,6,8	32	2	1	0%,25%,50%	one global PU	8192

the network size. The computation of the optimal solution on a modern Intel i7 with 3.4GHz took between 10s and multiple days. The second important observation is, that in the presence of PUs, the relative performance of the heuristic worsens to just 45% of the optimum. The reason for this lies in the proposed decomposition of the problem in two sub-tasks (Sec. III). First, we assign the spectrum shares to SUs independent from any PU. Afterwards we exclude any subcarriers being blocked by PUs. However, the random subchannel permutation scheme cannot guarantee that all SUs are equally affected by PUs.

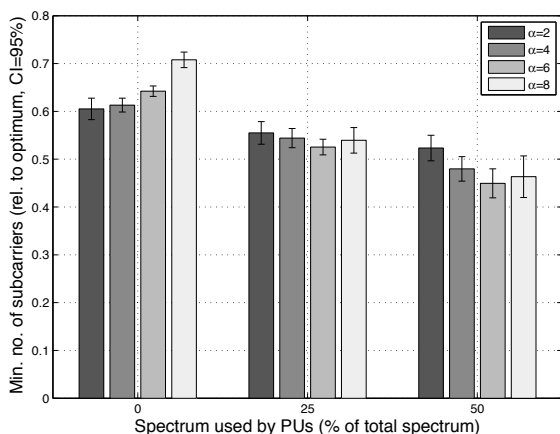

Fig. 9. Relative performance of the proposed algorithm to the global optimal solution. Random network topologies with different fixed node degree  $\alpha$  and different PU activity were evaluated.

## V. RELATED WORK

Opportunistic Spectrum Allocation (OSA) is a fundamental part of any CR technology and is therefore an often discussed research topic. A comprehensive survey of spectrum assignment strategies is given by Tragos et al. [7]. OSA strategies can be classified into centralized [8] and distributed [9], [10] approaches, further the existence of a CCC [11] is an important feature. Approaches for centralized CRNs, such as [8] have drawbacks as they need a CCC and they have poor scalability in dynamic environments. Nevertheless, distributed approaches have a low signaling overhead and are robust against infrastructure failures.

From physical layer perspective currently almost all approaches assume multiple narrow-band channels, e.g. [8], [9], [10] instead of using a single wideband channel and performing spectrum shaping using NC-OFDM [12]. In [13] a bonding scheme for WLAN channels is suggested to detect collisions in the frequency domain with a compound preamble.

Coexistence between SUs is also a little discussed topic. Especially in the future when CR systems are deployed in

parallel SUs must coexist without interference. One approach which considers PU needs and cooperative settings between SUs is described in [14]. The proposed scheme used a game theoretic approach to obtain the Nash equilibrium.

## VI. CONCLUSIONS

In this paper we proposed a low-complexity fully distributed heuristic for OSA in CRN which exploits the flexibility of NC-OFDM. In order to reduce the complexity we divided the overall OSA problem into two independent major tasks, namely collision-free (with respect to SUs) and interference-free (with respect to PUs) spectrum assignment. The performance of the proposed algorithm was evaluated by simulations and compared with the global optimum solution. The proposed heuristic is extremely efficient and has only a constant complexity of  $\mathcal{O}(1)$ .

## REFERENCES

- [1] Cisco Visual Networking, "Global mobile data traffic forecast update, 2012–2017," *Cisco White Paper*, February 2013.
- [2] P. Kryszkiewicz, H. Bogucka, and A. M. Wyglinski, "Protection of primary users in dynamically varying radio environment: practical solutions and challenges," *EURASIP Journal on wireless communications and networking*, vol. 2012, no. 1, pp. 1–20, 2012.
- [3] "LAN/MAN Standards Committee of the IEEE Computer Society, Part 22: Cognitive Wireless RAN Medium Access Control (MAC) and Physical Layer (PHY) Specifications: Policies and Procedures for Operation in the TV Bands," *IEEE Std 802.22-2011*, 2011.
- [4] H. Mahmoud, T. Yucek, and H. Arslan, "OFDM for cognitive radio: merits and challenges," *Wireless Communications, IEEE*, pp. 6–15, 2009.
- [5] D. Bertsekas and R. Gallager, *Data Networks*. Prentice-Hall, 1992.
- [6] S. Pomportes, A. Bussan, J. Tomasik, and V. Veque, "Resource allocation in ad hoc networks with two-hop interference resolution," in *Global Telecommunications Conference (GLOBECOM), IEEE*, 2011, pp. 1–6.
- [7] E. Tragos, S. Zeadally, A. Fragkiadakis, and V. Siris, "Spectrum assignment in cognitive radio networks: A comprehensive survey," *Communications Surveys Tutorials, IEEE*, vol. 15, pp. 1108–1135, 2013.
- [8] Y. Shi, Y. T. Hou, S. Kompella, and H. D. Sherali, "Maximizing capacity in multihop cognitive radio networks under the SINR model," *Transactions on Mobile Computing, IEEE*, vol. 10, pp. 954–967, 2011.
- [9] P. R. W. Junior, M. Fonseca, A. Munaretto, A. C. Viana, and A. Ziviani, "Zap: a distributed channel assignment algorithm for cognitive radio networks," *EURASIP Journal on Wireless Communications and Networking*, vol. 2011, no. 1, pp. 1–11, 2011.
- [10] J. Wu, Y. Dai, and Y. Zhao, "Effective channel assignments in cognitive radio networks," *Computer Communications*, vol. 36, no. 4, pp. 411–420, 2012.
- [11] B. F. Lo, "A survey of common control channel design in cognitive radio networks," *Physical Communication*, vol. 4, no. 1, pp. 26–39, 2011.
- [12] R. Rajbanshi, A. M. Wyglinski, and G. J. Minden, "An efficient implementation of NC-OFDM transceivers for cognitive radios," in *Cognitive Radio Oriented Wireless Networks and Communications Conference, IEEE*, 2006, pp. 1–5.
- [13] P. Huang, X. Yang, and L. Xiao, "Adaptive channel bonding in multicarrier wireless networks," in *Proceedings of the fourteenth ACM international symposium on Mobile ad hoc networking and computing*. ACM, 2013, pp. 297–300.
- [14] S. Tan, J. Zeidler, and B. Rao, "Opportunistic spectrum access for cognitive radio networks with multiple secondary users," *IEEE Transactions on Wireless Communications*, vol. 12, no. 12, pp. 6214–6227, 2013.